

# PRO HOOD FEATURES AND SPECIFICATIONS

## 10" PRO Hood

MODEL:  
BCH3010-PRO (30")  
BCH3610-PRO (36")

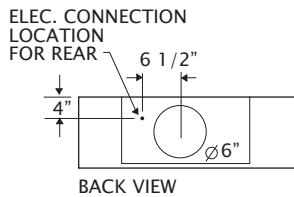
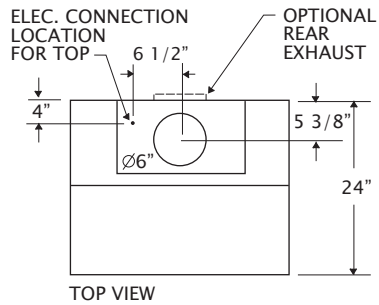
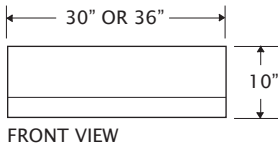
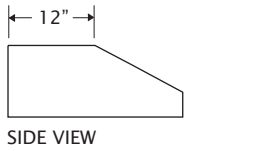

## 10" PRO Hood RECIRCULATING

MODEL:  
BCH3010R-PRO (30")  
BCH3610R-PRO (36")

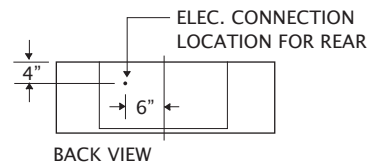
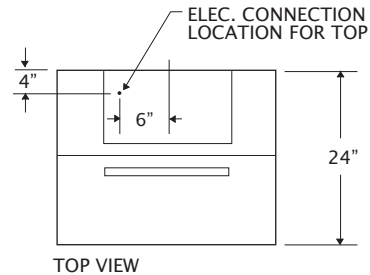
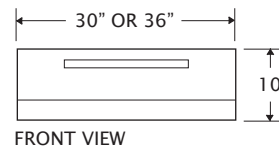
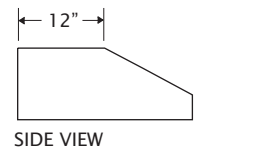

Dimensions	10"H x 30" or 36"W x 24"D
Vent	External, Reversible top or rear exhaust.
Blower	600 CFM
Electrical	120 VAC, 15 Amps

Dimensions	10"H x 30" or 36"W x 24"D
Vent	Recirculating
Blower	520 CFM
Electrical	120 V, 15 Amps

**FEATURES:**

Commercial grade 18 gauge 300 stainless steel construction, Welded seamless corners, Dishwasher safe stainless steel baffle filters, Variable blower control, Halogen lamps with dimmer control, Largest filtered capture in the industry

**INSTALL NOTES:** Allow 30"-36" between stove top and bottom of range hood (or per your local city codes).

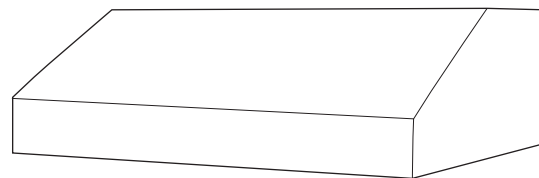

# PRO HOOD FEATURES AND SPECIFICATIONS

## 18" x 48" PRO Hood

MODEL:  
BC-PRO48HOOD

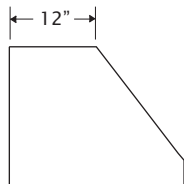

SIDE VIEW

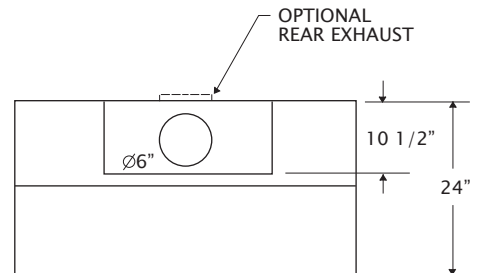

TOP VIEW

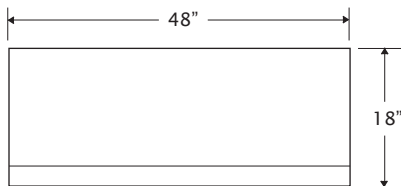

FRONT VIEW

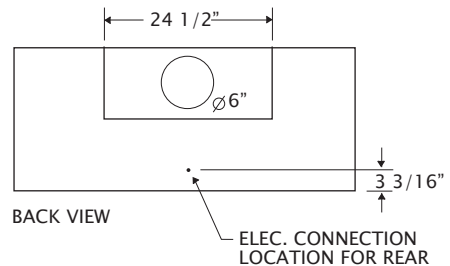

BACK VIEW

Dimensions	18"H x 48"W x 24"D
Vent	External, Reversible top or rear exhaust.
Blower	600 CFM
Electrical	120 VAC, 15 Amps

### FEATURES:

Commercial grade 16 gauge 300 stainless steel construction, Welded seamless corners, Dishwasher safe stainless steel baffle filters, Variable blower control, Halogen lamps with dimmer control, Largest filtered capture in the industry

INSTALL NOTES: Allow 30"-36" between stove top and bottom of range hood (or per your local city codes).

